

Features

- Low $R_{DS(on)}$
- Ultra-low Q_G For High Efficiency
- Logic Level
- Light Weight – 0.068 grams
- New Compact Hermetic Package
- Source Sense Pin
- Total Dose
 - Rated to 300 krad
- Single Event
 - SEE immunity for LET of 83.7 MeV/mg/cm² with V_{DS} up to 100% of rated Breakdown
- Low Dose Rate at 100 mRad/sec
 - Maintains Pre-Rad specification
- Neutron
 - Maintains Pre-Rad specification for up to 1×10^{13} Neutrons/cm²

Application

- Commercial Satellite EPS & Avionics
- Deep Space Probes
- High Speed Rad Hard DC-DC Conversion
- Rad Hard Motor Controllers

Thermal Characteristics

Symbol	Parameter-Conditions	Value	Units
$R_{\theta JA}$	Thermal Resistance Junction to Ambient (Note 3)	62	°C/W
$R_{\theta JC}$	Thermal Resistance Junction to Case	9.8	



FBG10N05A

Rad Hard e-GaN[®] 100 V, 5 A, 44 mΩ Surface Mount (FSMD-A)

Description

EPC Space series of eGaN[®] power switching HEMTs have been specifically designed for critical applications in the high reliability or commercial satellite space environments. These devices have exceptionally high electron mobility and a low temperature coefficient resulting in very low $R_{DS(on)}$ values. The lateral structure of the die provides for very low gate charge (Q_G) and extremely fast switching times. These features enable faster power supply switching frequencies resulting in higher power densities, higher efficiencies and more compact packaging.

I/O Pin Assignment (Bottom View)

Pin	Symbol	Description
1	G	Gate
2	D	Drain
3	SS	Source Sense
4	S	Source

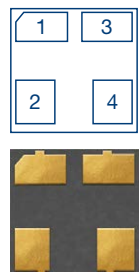

Absolute Maximum Rating ($T_C = 25^\circ\text{C}$ unless otherwise noted)

Symbol	Parameter-Conditions	Value	Units
V_{DS}	Drain to Source Voltage (Note 1)	100	V
I_D	Continuous Drain Current I_D @ $V_{GS} = 5\text{ V}$, $T_C = 25^\circ\text{C}$, $R_{\theta JA} < 62^\circ\text{C/W}$	5	A
I_{DM}	Single-Pulse Drain Current $t_{pulse} \leq 80\ \mu\text{s}$	20	
V_{GS}	Gate to Source Voltage (Note 2)	+6 / -4	V
T_J, T_{STG}	Operating and Storage Junction Temperature Range	-55 to +150	°C
T_{sol}	Package Mounting Surface Temperature	260	
ESD	ESD Class	$\Delta 1A$	

Electrical Characteristics ($T_C = 25^\circ\text{C}$ unless otherwise noted. Typical (TYP) values are for reference only.)

Parameter	Symbol	Test Conditions	MIN	TYP	MAX	Units	
Maximum Drain to Source Voltage	V_{DSMAX}	$V_G = 0\text{ V}$	-	-	100	V	
Drain to Source Leakage	I_{DSS}	$V_{DS} = 100\text{ V}$ $V_{GS} = 0\text{ V}$	$T_C = 25^\circ\text{C}$	-	10	60	μA
			$T_C = 125^\circ\text{C}$	-	100	150	
Gate to Source Forward Leakage	I_{GSSF}	$V_{GS} = 5\text{ V}$	$T_C = 25^\circ\text{C}$	-	0.25	2	mA
Gate to Source Reverse Leakage	I_{GSSR}	$V_{GS} = -4\text{ V}$	$T_C = 25^\circ\text{C}$	-60	-20		μA
Gate to Source Threshold Voltage	$V_{GS(th)}$	$V_{DS} = V_{GS}$, $I_D = 1.2\text{ mA}$	$T_C = 25^\circ\text{C}$	0.8	1.2	2.5	V
Gate to Source Threshold Voltage Temperature Coefficient	$\Delta V_{GS(th)}/\Delta T$	$V_{DS} = V_{GS}$, $I_D = 1.2\text{ mA}$	$-55^\circ\text{C} < T_A < 150^\circ\text{C}$	-	3.8	-	mV/°C
Drain to Source Resistance (Note 4)	$R_{DS(on)}$	$I_D = 5\text{ A}$, $V_{GS} = 5\text{ V}$	$T_C = 25^\circ\text{C}$	-	36	44	m Ω
Source to Drain Forward Voltage (Note 5)	V_{SD}	$I_S = 0.5\text{ A}$, $V_G = 0\text{ V}$	$T_C = 25^\circ\text{C}$		2.5		V

Dynamic Characteristics ($T_C = 25^\circ\text{C}$ unless otherwise noted. Typical (TYP) values are for reference only.)

Parameter	Symbol	Test Conditions	MIN	TYP	MAX	Units
Input Capacitance	C_{ISS}	$f = 1\text{ MHz}$, $V_{DS} = 50\text{ V}$, $V_{GS} = 0\text{ V}$ (Note 6)		207	233	pF
Output Capacitance	C_{OSS}			133	170	
Reverse transfer Capacitance	C_{RSS}			19	23	
Gate Resistance	R_G	$f = 1\text{ MHz}$, $V_{DS} = V_{GS} = 0\text{ V}$		0.4		Ω
Total Gate Charge (Note 7)	Q_G	$I_D = 5\text{ A}$, $V_{GS} = 5\text{ V}$, $V_{DS} = 50\text{ V}$		1.7	2.2	nC
Gate to Drain Charge (Note 7)	Q_{GD}	$I_D = 5\text{ A}$, $V_{GS} = 5\text{ V}$, $V_{DS} = 50\text{ V}$		0.2	0.6	
Gate to Source Charge (Note 7)	Q_{GS}	$I_D = 5\text{ A}$, $V_{GS} = 5\text{ V}$, $V_{DS} = 50\text{ V}$		0.5	1.0	
Output Charge (Note 8)	Q_{OSS}	$V_{GS} = 0\text{ V}$, $V_{DS} = 50\text{ V}$		9.1	-	
Source to Drain Recovery Charge	Q_{RR}	$I_D = 5\text{ A}$, $V_{DS} = 50\text{ V}$		<1		

Radiation Characteristics

EPC Space eGaN[®] HEMTs are tested according to MIL-STD-750 Method 1019 for total ionizing dose validation. Every manufacturing lot is tested for total ionizing dose of Gamma radiation with an in-situ bias for (i) $V_{GS} = 5\text{ V}$, (ii) $V_{DS} = V_{GS} = 0\text{ V}$ and (iii) $V_{DS} = 80\% B_{VDSS}$.

Electrical Characteristics up to 300 krad ($T_C = 25^\circ\text{C}$ unless otherwise noted. Typical (TYP) values are for reference only.)

Parameter	Symbol	Test Conditions	MIN	TYP	MAX	Units
Maximum Drain to Source Voltage	V_{DSMAX}	$V_{GS} = 0\text{ V}$	-	-	100	V
Gate to Source Threshold Voltage	$V_{GS(th)}$	$V_{DS} = V_{GS}$, $I_D = 1.2\text{ mA}$	0.8	1.2	2.5	V
Drain to Source Leakage	I_{DSS}	$V_{DS} = 100\text{ V}$, $V_{GS} = 0\text{ V}$	-	10	250	μA
Gate to Source Forward Leakage	I_{GSS}	$V_{GS} = 5\text{ V}$	-	0.25	2	mA
Gate to Source Reverse Leakage	I_{GSS}	$V_{GS} = -4\text{ V}$	-	-20	-60	μA
Drain to Source Resistance (Note 4)	$R_{DS(on)}$	$I_D = 5\text{ A}$, $V_{GS} = 5\text{ V}$	-	-	38	$\text{m}\Omega$

Typical Single Event Effect Safe Operating Area

Note : All Single Event Effect testing is performed on the K-500 Cyclotron at Texas A&M University

Test	Environment			V_{DS} Voltage (V)		
	Ion	LET MeV/mg/cm^2	Range μm	Energy MeV	$V_{GS} = 0\text{ V}$	$V_{GS} = -4\text{ V}$
See SOA	Xe	50	131	1653	100	100
	Au	83.7	130	2482	100	100

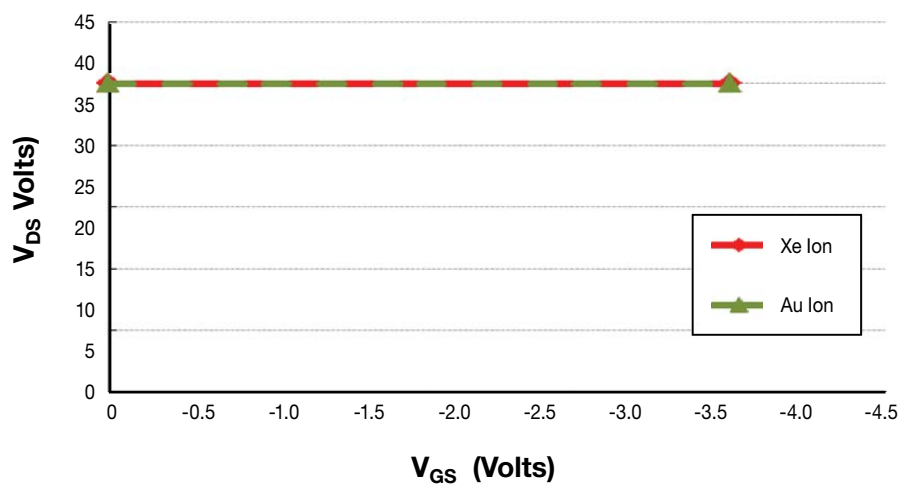

Figure 1. Typical Single Event Effect Safe Operating Area

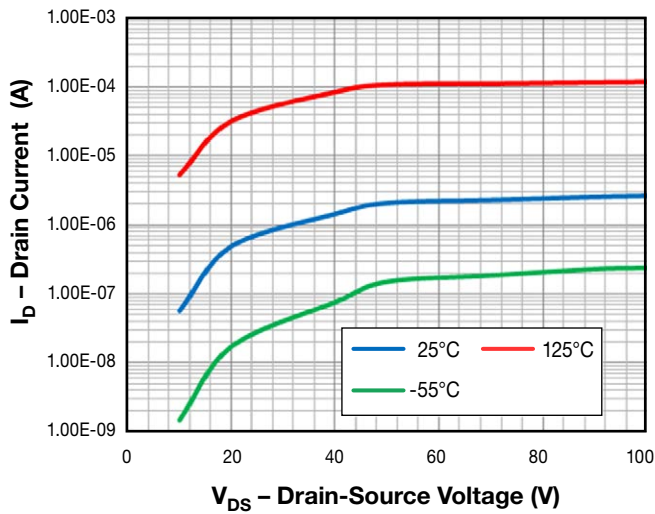

Figure 2. Typical Drain-Source Leakage Current vs. Ambient Temperature

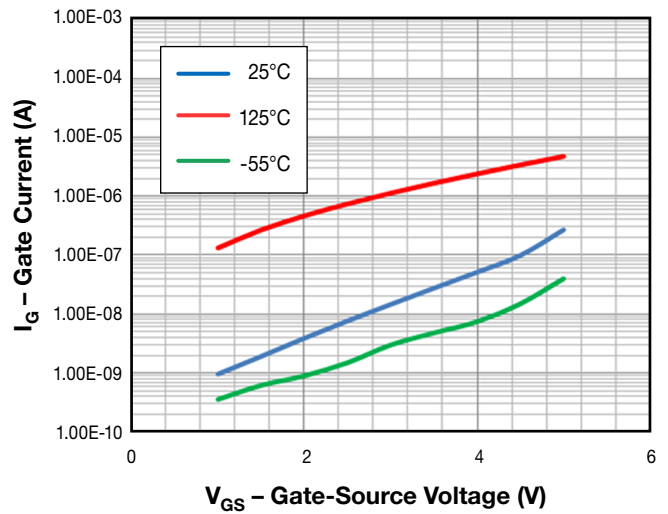

Figure 3. Gate-Source Leakage Current vs. Ambient Temperature

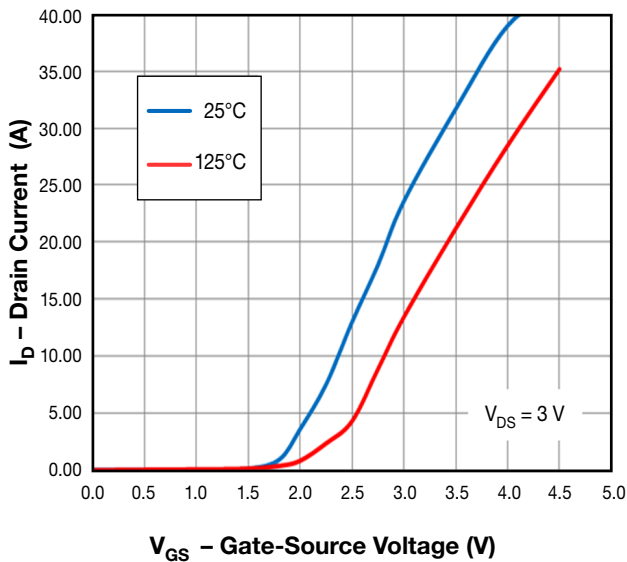

Figure 4. Typical Gate-Drain Transfer Characteristic

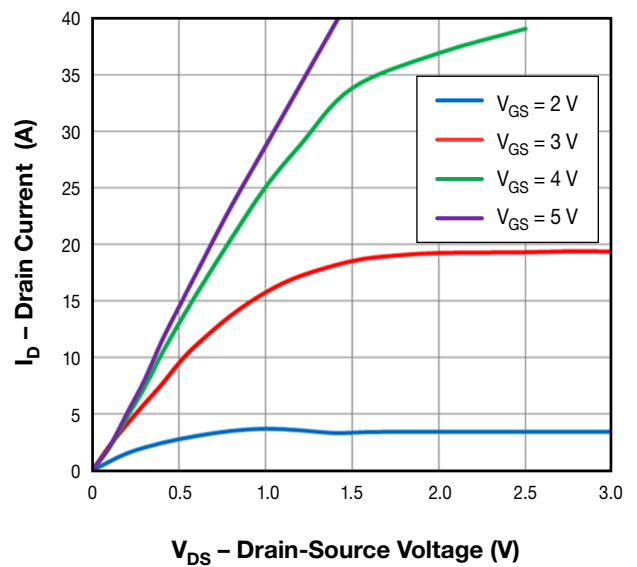

Figure 5. Typical Output Characteristics

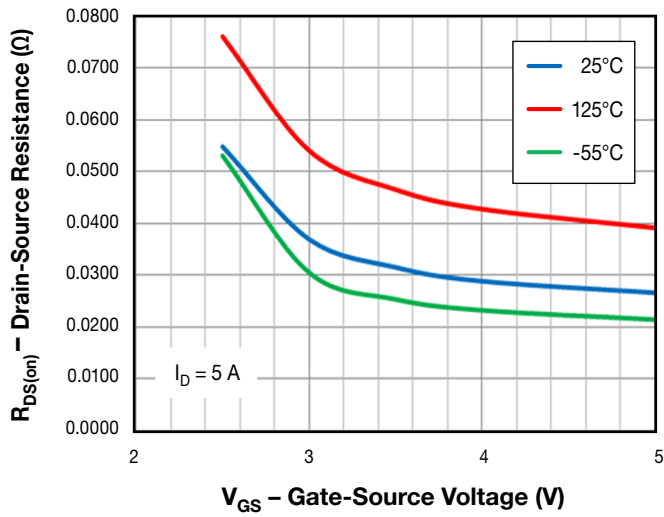

Figure 6. Typical Drain-Source ON Resistance vs. Gate-Source Voltage vs. Ambient Temperature

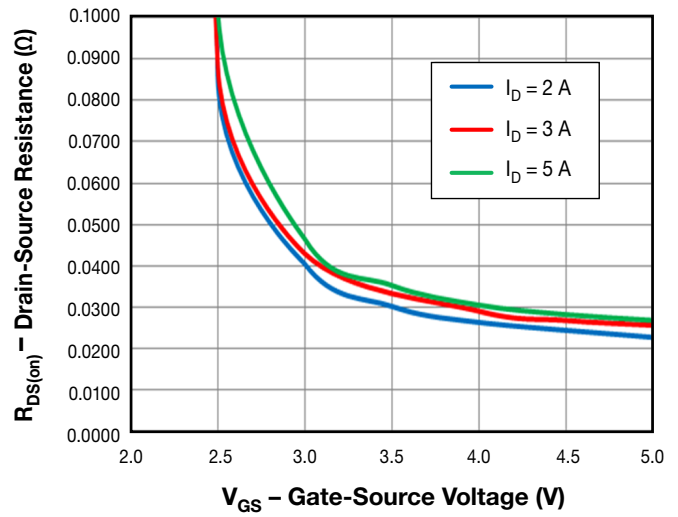

Figure 7. Typical Drain-Source ON Resistance vs. Gate-Source Voltage vs. Drain Current

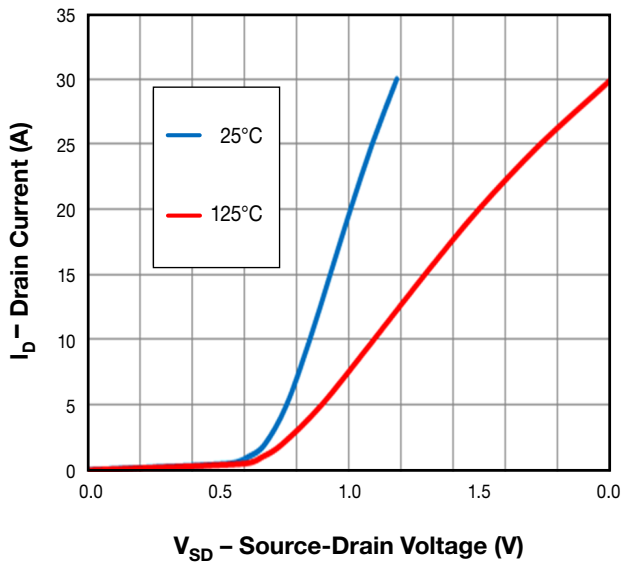

Figure 8. Typical Source-Drain Voltage vs. Temperature

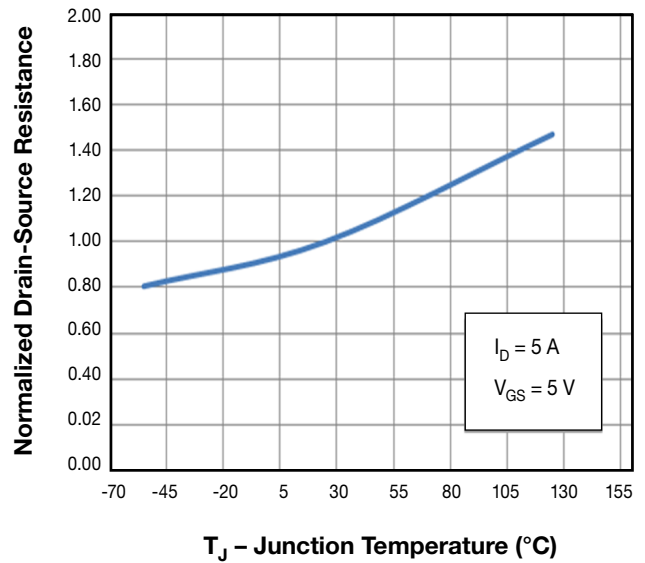

Figure 9. Normalized Drain-Source ON Resistance vs. Ambient Temperature

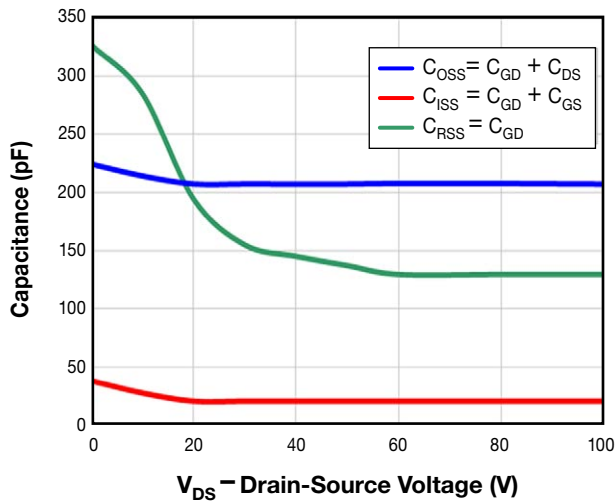

Figure 10. Typical Inter-Electrode Capacitance vs. Drain-Source Voltage

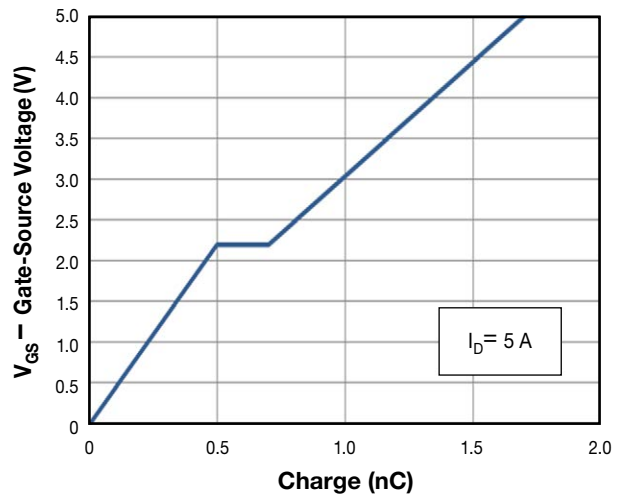

Figure 11. Typical Gate Charge vs. Drain Current

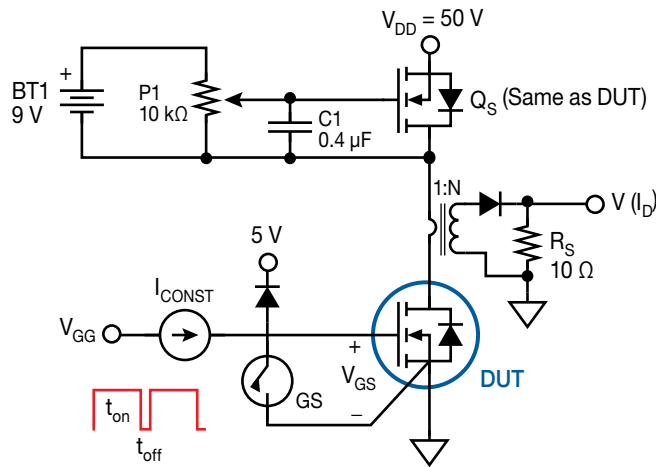

Figure 12. Charge Test Circuit

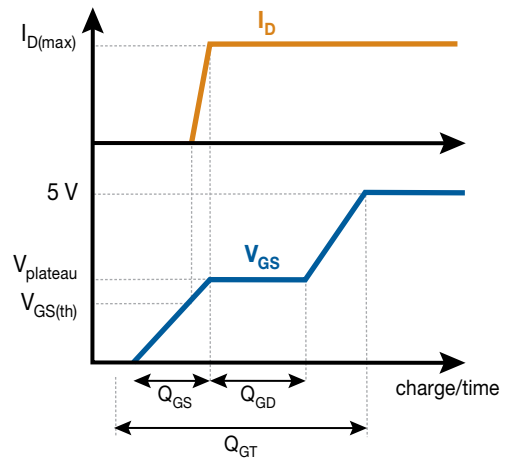
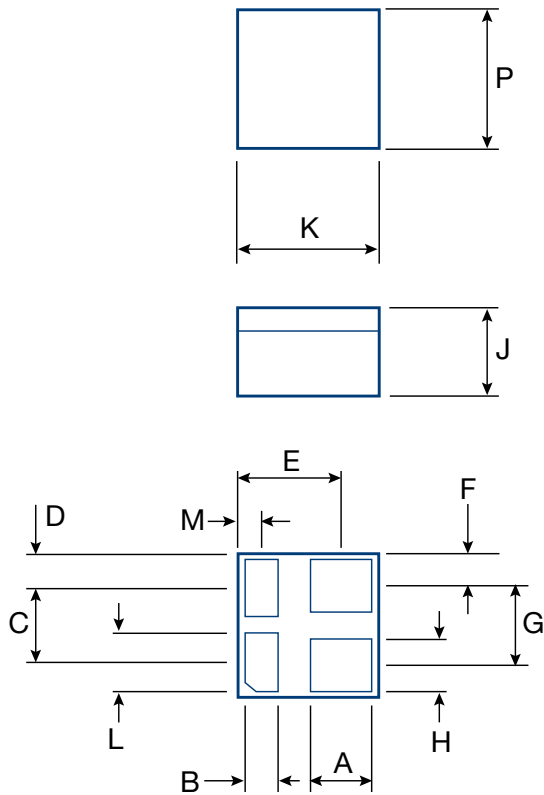

Figure 13. Typical Gate Charge Test Waveform

Package Outline and Dimensions



Symbol	Inches		Millimeters		Note
	MIN	MAX	MIN	MAX	
A	0.052	0.062	1.320	1.574	
B	0.027	0.037	0.685	0.939	
C	0.063	0.073	1.600	1.854	
D	0.026	0.036	0.660	0.914	
E	0.092	0.102	2.336	2.590	
F	0.024	0.034	0.609	0.863	
G	0.068	0.078	1.727	1.981	
H	0.042	0.052	1.066	1.320	
J	0.080	0.090	2.032	2.286	Ref. only
K	0.125	0.135	3.175	3.429	
L	0.048	0.058	1.219	1.473	
M	0.016	0.026	0.406	0.664	
P	0.125	0.135	3.175	3.429	

FSMD-A Footprint for Printed Circuit Board Design

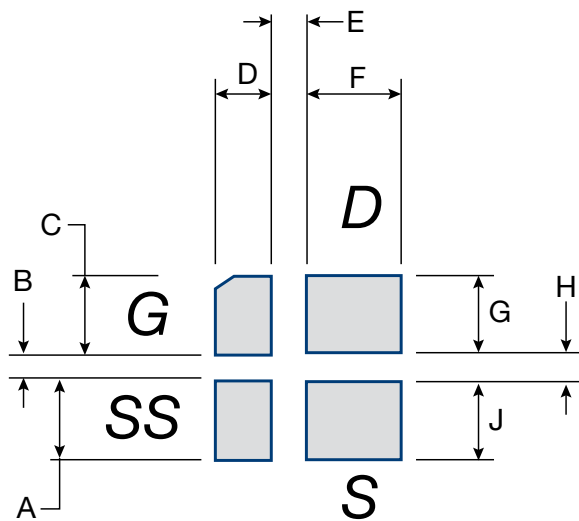

Symbol	Inches		Millimeters		Note
	MIN	MAX	MIN	MAX	
A	0.051	0.061	1.295	1.549	
B	0.010	0.020	0.254	0.508	
C	0.051	0.061	1.295	1.549	
D	0.033	0.043	0.838	1.092	
E	0.020	0.030	0.508	0.762	
F	0.058	0.068	1.473	1.727	
G	0.048	0.058	1.219	1.473	
H	0.015	0.025	0.381	0.635	
J	0.048	0.058	1.219	1.473	

Notes

- Note 1. NEVER exceed the absolute maximum V_{DS} of the device otherwise permanent damage/destruction may result.
- Note 2. NEVER exceed the absolute maximum V_{GS} of the device otherwise permanent damage/destruction may result. We recommend use at no greater than +5 V as the HEMT is fully conducting at this point.
- Note 3. $R_{\theta JA}$ measured with FSMD-A package mounted to double-sided PCB, 0.063" thickness with 1.0 square inches of copper area on the top (mounting side) and a flood etch (3 square inches) on the bottom side.
- Note 4. Measured using four wire (Kelvin) sensing and pulse measurement techniques. Measurement pulse width is 80 μ s and duty cycle is 1%, maximum.
- Note 5. Operation of the device in the third quadrant region is not recommended.
- Note 6. $C_{ISS} = C_{GS} + C_{GD}$ with C_{DS} shorted. $C_{OSS} = C_{DS} + C_{GD}$. $C_{RSS} = C_{GD}$.
- Note 7. The gate charge parameters are measured using the circuit shown in Figure 11. Qs and associated components BT1, P1 and C1 form a high speed current source that serves as the test load for the DUT. A constant gate current (I_{const}) of 1.5-3 mA is provided to the Gate of the DUT during the time that the ground switch (G_S) is OFF (t_{off}). The DUT is switched ON and OFF using ground-sensed switch GS. The gate current is adjusted to yield the desired charge per unit time ($I_{const} \cdot \text{time per division}$) on the measuring oscilloscope. The GS pulse drive ON time (t_{on}) is adjusted for the desired observability of the gate-source voltage (V_{GS}) waveform. The maximum duty cycle of the ground switch (t_{off}/t_{on}) should be set to 1% maximum. Please note that all gate-related signals are referenced to the "Source Sense" pin on the package. At all times during the measurement, the maximum gate-source voltage is clamped to 5 V_{DC} .
- Note 8. Guaranteed by design/device construction. Not tested.

EPC Space Part Number Information

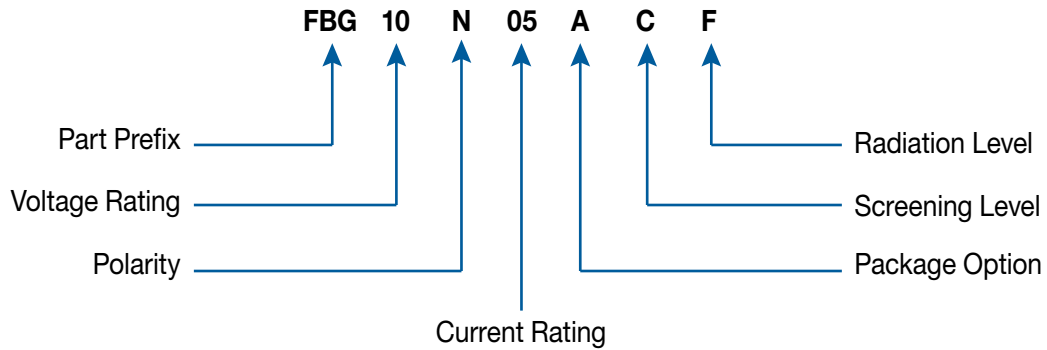

Ordering Information Availability

Screening Options	Rad Assurance Options
1 character	1 character
C = Developmental Unit V = Lite Screened S = Space Level ¹	R = 100 krad, LET = 64 F = 300 krad, LET = 64 G = 500 krad, LET = 64 H = 1000 krad, LET = 64 Z = 1000 krad, LET = 84

Part Number	Screening Level	Shipping
FBG10N05A*C	Engineering Samples	Waffle trays
FBG10N05A*S	Space Level	

¹ Screening and qualification consistent to an equivalent MIL-PRF-19500 specification.

C version FSMD-A units are intended for engineering development purposes only and NOT supplied with radiation performance guarantees nor supplemental data packages

EPC Space Product Marking Information

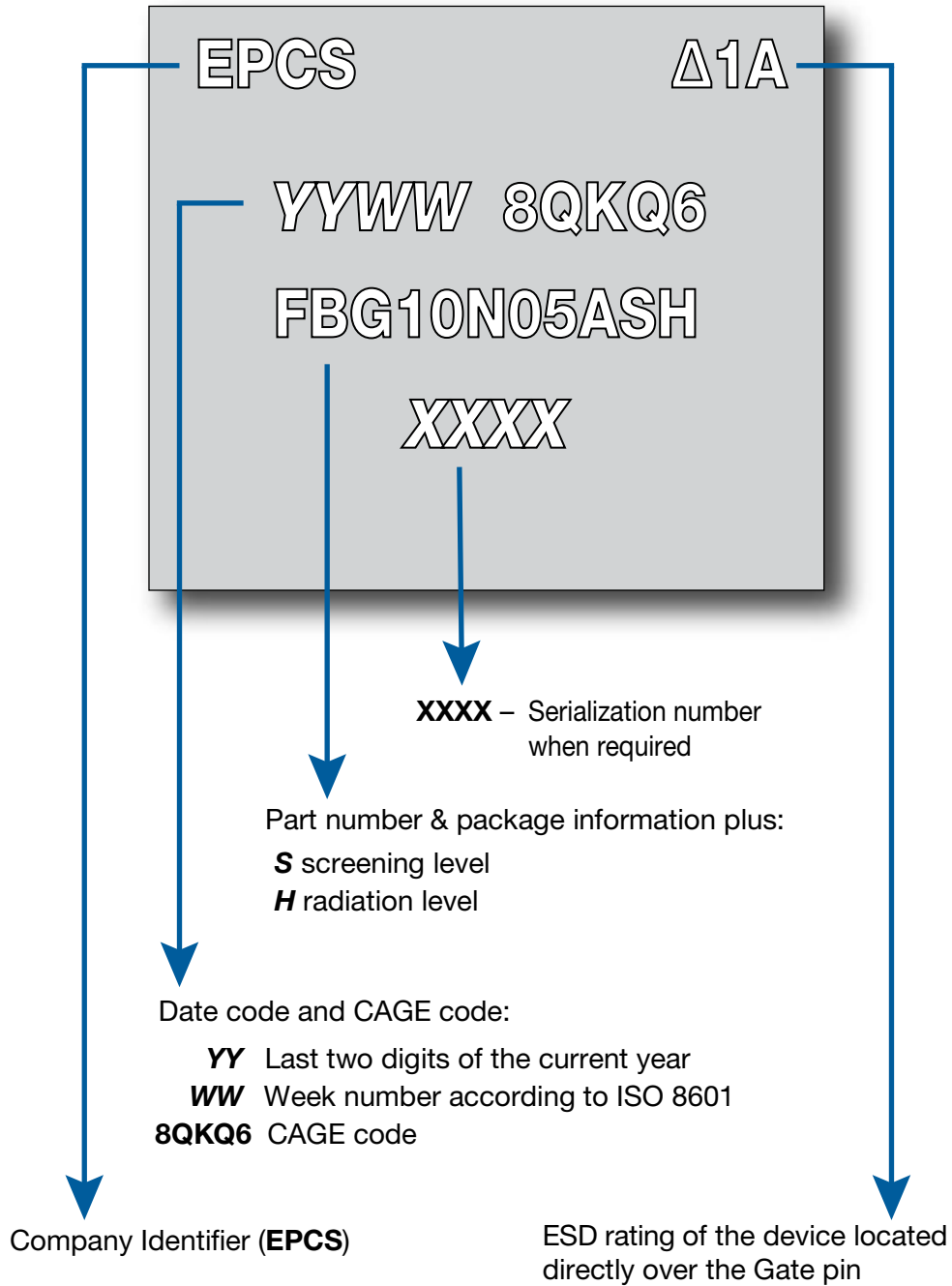

Data Package Order Detail

Consistent to MIL-PRF-19500 general specification

SPACE Screen

1. FBG10N05A*S – STANDARD DATA PACKAGE

- A. Certificate of Compliance
- B. Serialization Records
- C. Preconditioning – Attributes Data Sheet
 - HTRB - Hi Temp Gate Stress Post Reverse Bias Data and Delta Data
 - HTRB - Hi Temp Drain Stress Post Reverse Bias Delta Data
- D. Group A – Attributes Data Sheet
- E. Group B – Attributes Data Sheet
- F. Group D – Attributes Data Sheet

2. FBG10N05A*S – OPTIONAL DATA PACKAGE

- A. Certificate of Compliance
- B. Serialization Records
- C. Assembly Flow Chart
- D. SEM Photos and Report
- E. Preconditioning – Attributes Data Sheet
 - HTRB - Hi Temp Gate Stress Post Reverse Bias Data and Delta Data
 - HTRB - Hi Temp Drain Stress Post Reverse Bias Delta Data
 - X-Ray and X-Ray Report
- F. Group A – Attributes Data Sheet
 - Subgroups A1, A2, A3, and A7 Data
- G. Group B – Attributes Data Sheet
 - Subgroups B1, B2, B3, B4, B5 and B6 Data
- H. Group C – Attributes Data Sheet
 - Subgroups C1, C2, C3, C4, C6 and C7 Data
- I. Group D – Attributes Data Sheet
 - Pre and Post Radiation Data

Disclaimers

ALL PRODUCT, PRODUCT SPECIFICATIONS AND DATA ARE SUBJECT TO CHANGE WITHOUT NOTICE TO IMPROVE RELIABILITY, FUNCTION OR DESIGN OR OTHERWISE. EPC Space Corporation, its affiliates, agents, employees, and all persons acting on its or their behalf (collectively, “EPC Space”), disclaim any and all liability for any errors, inaccuracies or incompleteness contained in any datasheet or in any other disclosure relating to any product. EPC Space makes no warranty, representation or guarantee regarding the suitability of the products for any particular purpose. To the maximum extent permitted by applicable law, EPC Space disclaims (i) any and all liability arising out of the application or use of any product, (ii) any and all liability, including without limitation special, consequential or incidental damages, and (iii) any and all implied warranties, including warranties of fitness for particular purpose, non-infringement and merchantability. Statements regarding the suitability of products for certain types of applications are based on EPC Space market knowledge of typical requirements that are often placed on similar technologies in generic applications. Product specifications do not expand or otherwise modify EPC Space terms and conditions of purchase, including but not limited to the warranty expressed therein. Except as expressly indicated in writing, EPC Space products are not designed for use in medical, life-saving, or life-sustaining applications or for any other application in which the failure of the EPC Space product could result in personal injury or death. Customers using EPC Space products not expressly indicated for use in such applications do so at their own risk. Please contact authorized EPC Space personnel to obtain written terms and conditions regarding products designed for such applications. No license, express or implied, by estoppel or otherwise, to any intellectual property rights is granted by this document or by any conduct of EPC Space. Product names and markings noted herein may be trademarks of their respective owners.

Export Administration Regulations (EAR)

The products described in this datasheet could be subjected to the Export Administration Regulations (EAR). They may require an approved export license prior to export from the United States. An export includes release of product or disclosure of technology to a foreign national inside or outside the United States.

International Traffic in Arms Regulations (ITAR)

The products described in this datasheet could be subjected to the International in Arms Regulations (ITAR). They require an approved export license prior to export from the United States. An export includes release of product or disclosure of technology to a foreign national inside or outside the United States.

Patents

EPC Space holds numerous U.S patent. Any that apply to the product(s) listed in this document are identified by markings on the product(s) or on internal components of the product(s) in accordance with U.S Patent laws

eGaN® is a registered trademark of Efficient Power Conversion Corporation, Inc. Data and specification subject to change without notice.

Revisions

Datasheet Revision	Product Status
REV P#	Proposal/development
REV Q#	Characterization and Qualification
M-700-003-E	Production Released

Information subject to change without notice.

Revised November, 2020

Contact EPC Space for further information and to order:

Email: sales@epc.space

Phone: +1 978 208 1334

Website: epc.space

Address: 17 Parkridge Road
 Unit # E
 Haverhill, MA 01835
 USA